

ENG

Rondi 3 Folding Wardrobe

UA

Розпашна шафа Ронді 3

1950x1208x516 mm

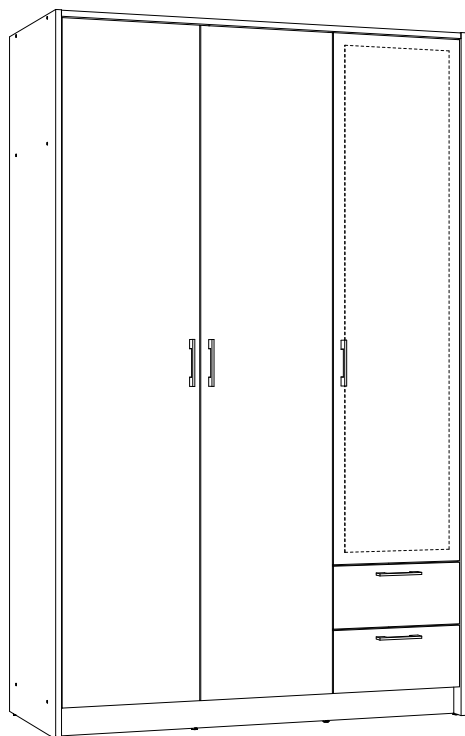

The central door can be equipped with mirrors.  
Please specify when purchasing.  
Центральні двері можна оснастити дзеркалами.  
Уточнійте при покупці.

### Additional Configuration

(Must be purchased separately)

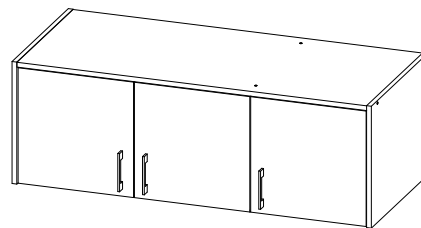

### Додаткове комплектування

(Необхідно придбати окремо)

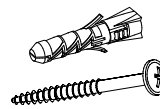

#### To avoid falling

we recommend fixing the product to the wall using **corners** or **double-sided tape**

#### Щоб уникнути падіння виробу

рекомендуємо закріпити його до стіни кутиками чи двосторонньою стрічкою.

ENG

UA

ENG



UA

#### RULES FOR USE AND CARE OF FURNITURE

1. Use furniture only in dry rooms protected from the effects of weather conditions.
2. Install with suitable tools according to these assembly instructions.
3. Try to assemble as close to the location as possible.
4. The body is assembling in a horizontal position.
5. Before moving furniture, make sure that it is not loaded with items.

**Caution:** moving furniture may damage it.  
When moving, hold on to vertical elements only; moving furniture by horizontal parts can break the product.

6. Overloading the furniture can damage it.
7. From time to time check the fittings and their correct position.
8. Wipe the furniture surface only with a slightly damp cloth or paper towels. Do not use chemical cleaning agents other than those specifically made for this.

#### ПРАВИЛА ВИКОРИСТАННЯ ТА ДОГЛЯДУ ЗА МЕБЛЯМИ

1. Використовуйте меблі тільки в сухих приміщеннях, захищених від впливу погодних умов.
2. Виконуйте установку за допомогою відповідних інструментів відповідно до даної інструкції зі складання.
3. Намагайтеся проводити збірку якомога ближче до місця використання.
4. Збірка корпусу здійснюється в горизонтальному положенні.
5. Перед переміщенням меблів переконайтеся, що вони не навантажені.  
**Увага:** переміщення меблів може привести до її пошкодження.  
При переміщенні тримайтеся тільки за вертикальні елементи, переміщаючи меблі за горизонтальні деталі ви можете зламати виріб.
6. Перевантаження меблів може привести до їх пошкодження.
7. Час від часу перевіряйте кріплення і правильність їх положення.
8. Протирайте поверхню меблів тільки добре віджатою вологою тканиною або ж паперовими рушниками. Не використовуйте хімічні засоби для очищення, крім спеціально для цього призначених.

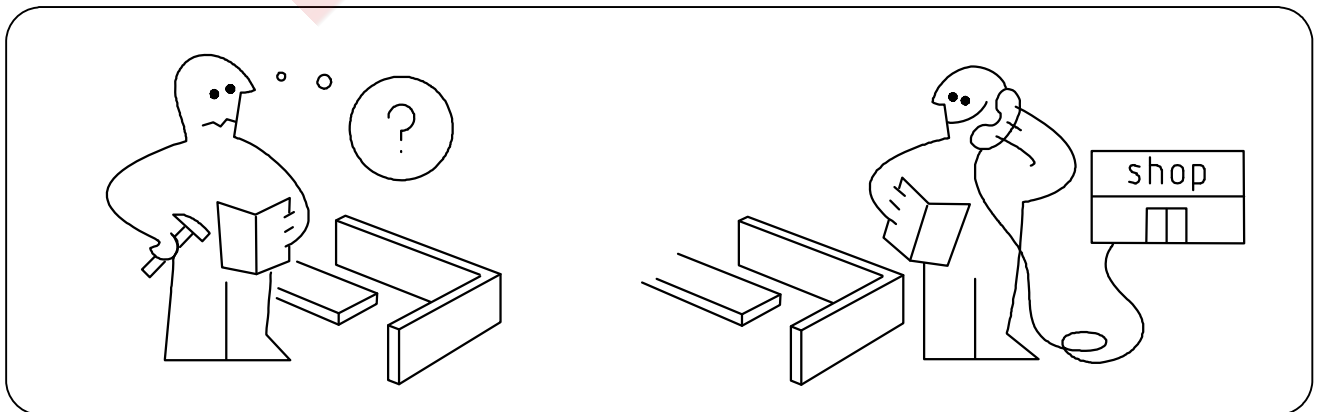
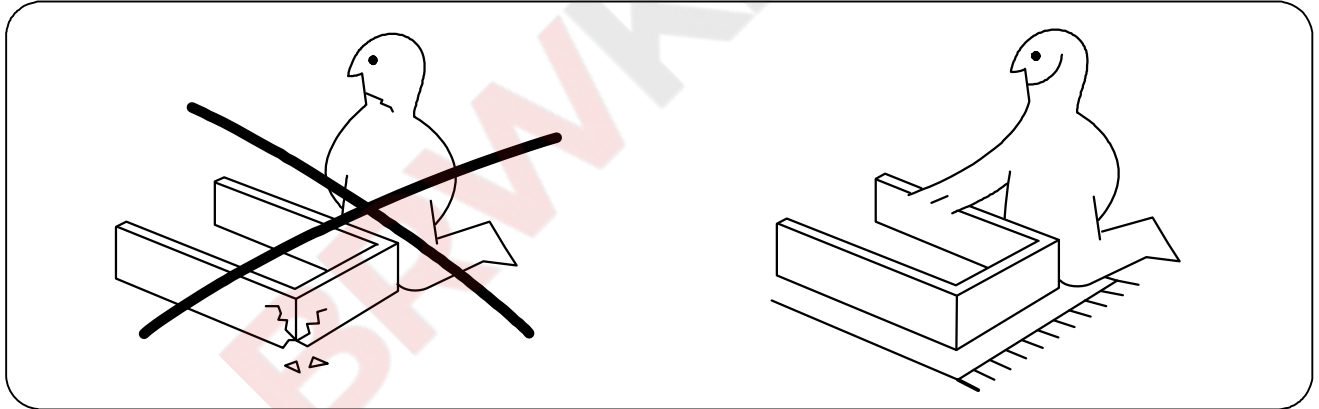
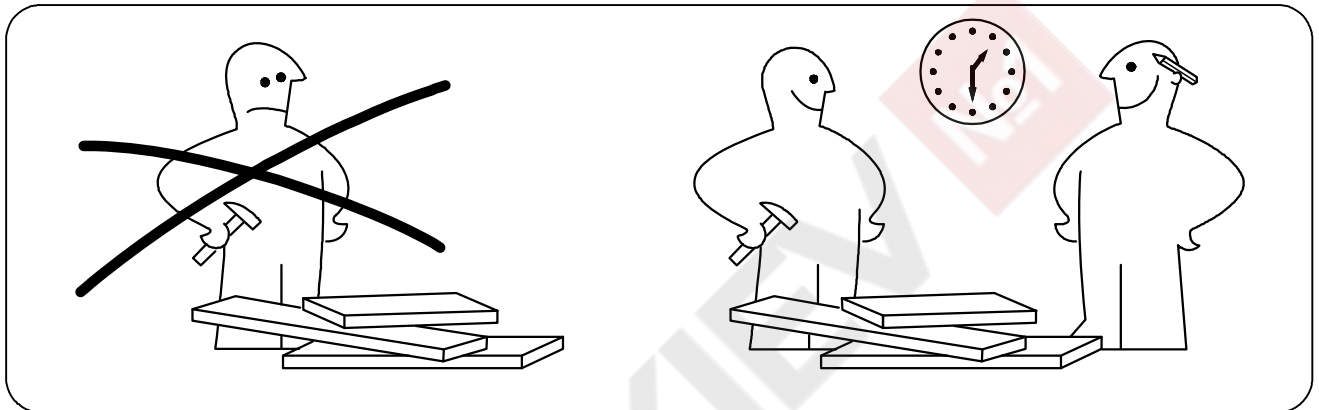
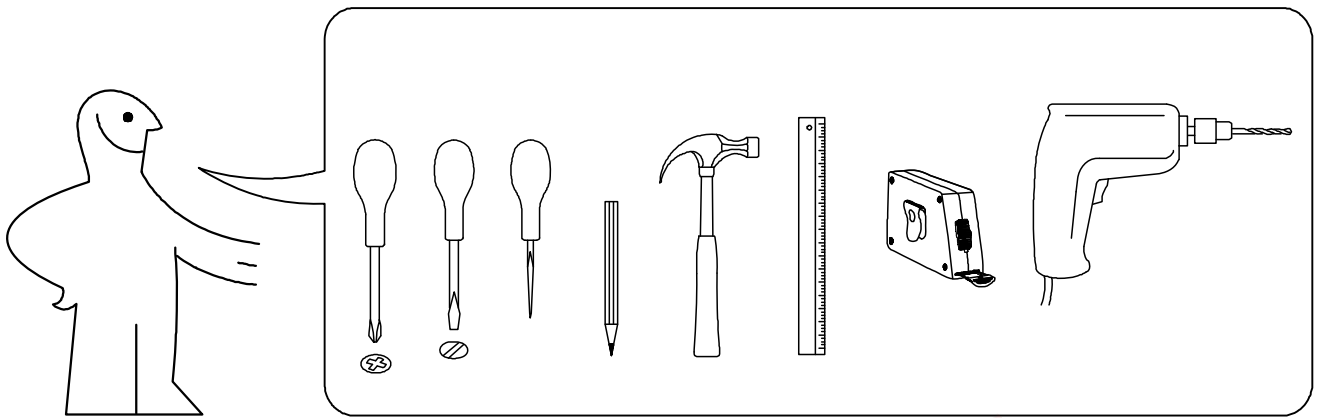

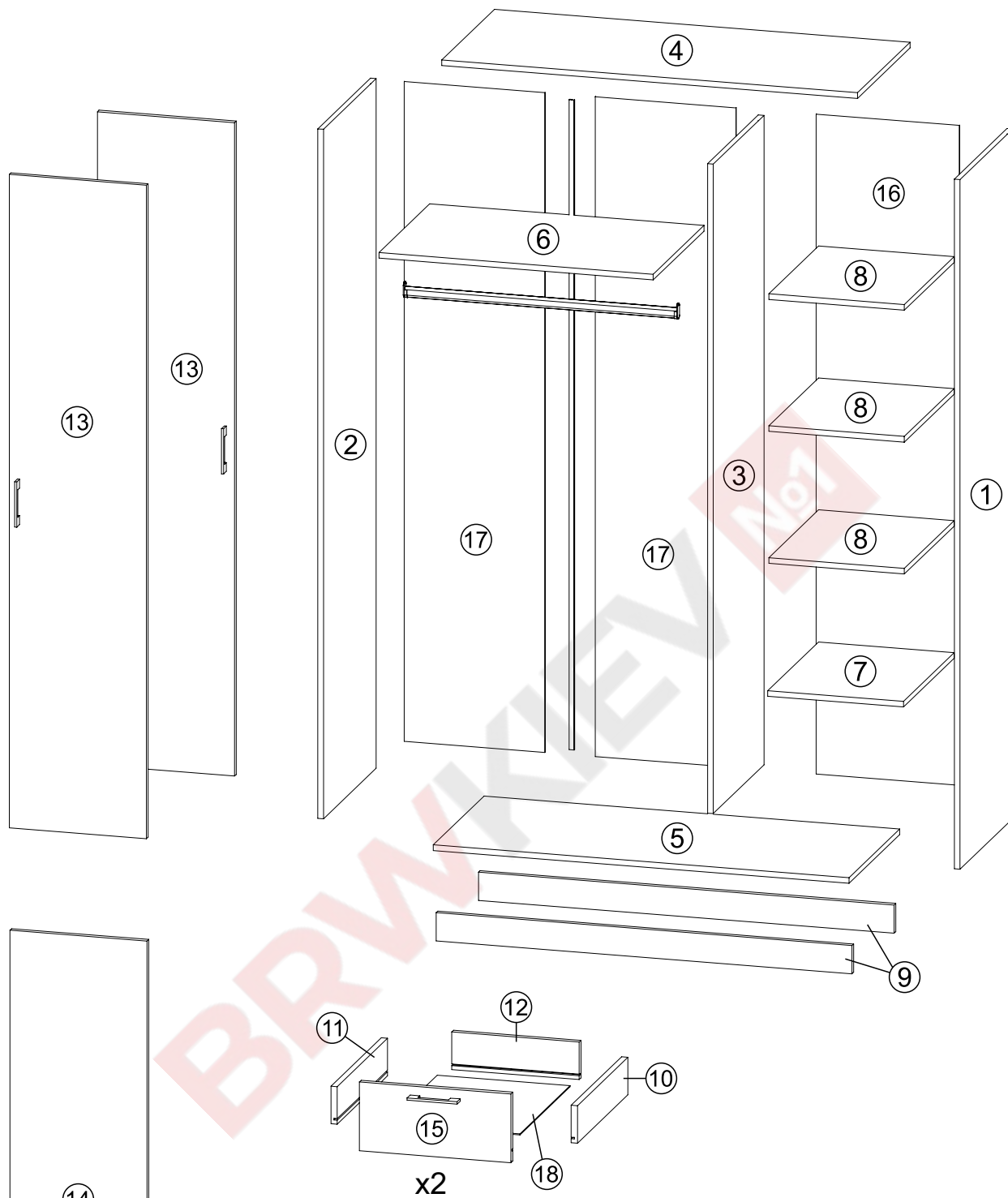

№	size / розмір		pack / уп.	qty / к-ть
1	1950	520	1/3	1
2	1950	520	1/3	1
3	1837	500	1/3	1
4	1176	519	2/3	1
5	1176	500	2/3	1
6	776	500	2/3	1
7	384	500	2/3	1
8	383	490	2/3	3
9	1176	80	2/3	2
10	450	96	2/3	2

№	size / розмір		pack / уп.	qty / к-ть
11	450	96	2/3	2
12	326	96	2/3	2
13	1848	388	3/3	2
14	1488	388	3/3	1
15	388	176	3/3	2
16	1866	405	1/3	1
17	1866	398	1/3	2
18	447	340	1/3	2
<b>Mirror (optional) / Дзеркало (додатково):</b>				
19	1420	320	3/3	1

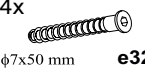
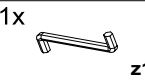

**2**  
**x2**

- 4x   $\phi 7 \times 50$  mm e32
- 1x  z1

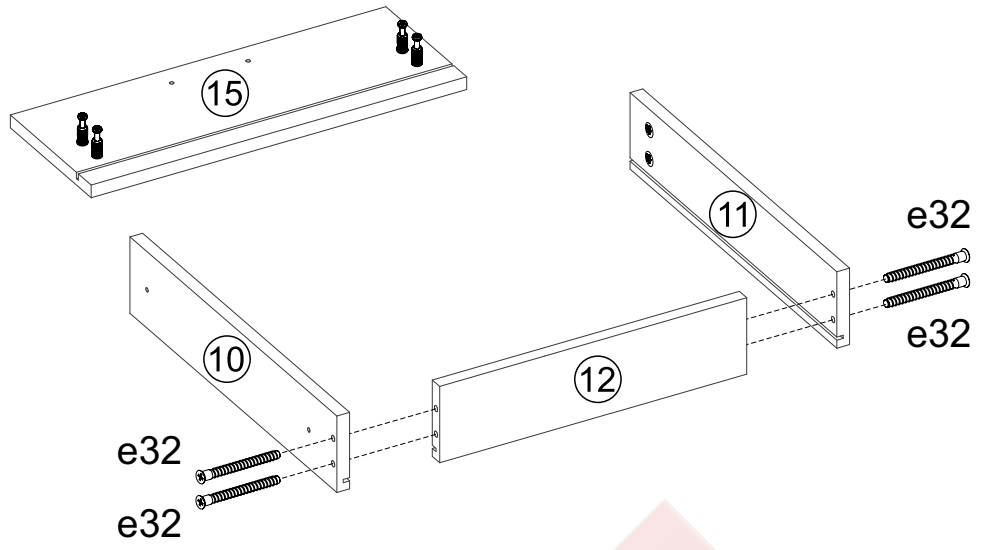
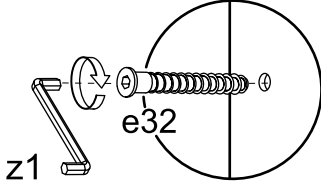



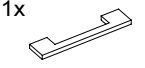
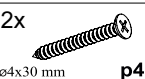

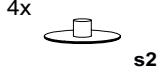
**3**  
**x2**

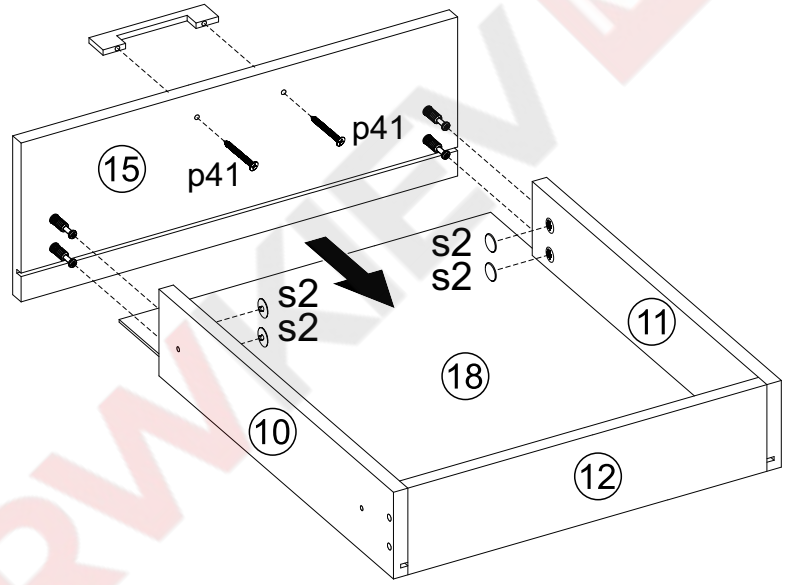
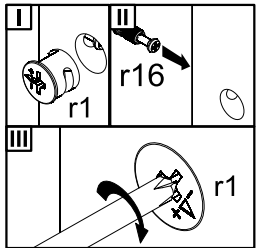
- 1x  z1
- 2x   $\phi 4 \times 30$  mm p41

- 4x  s2



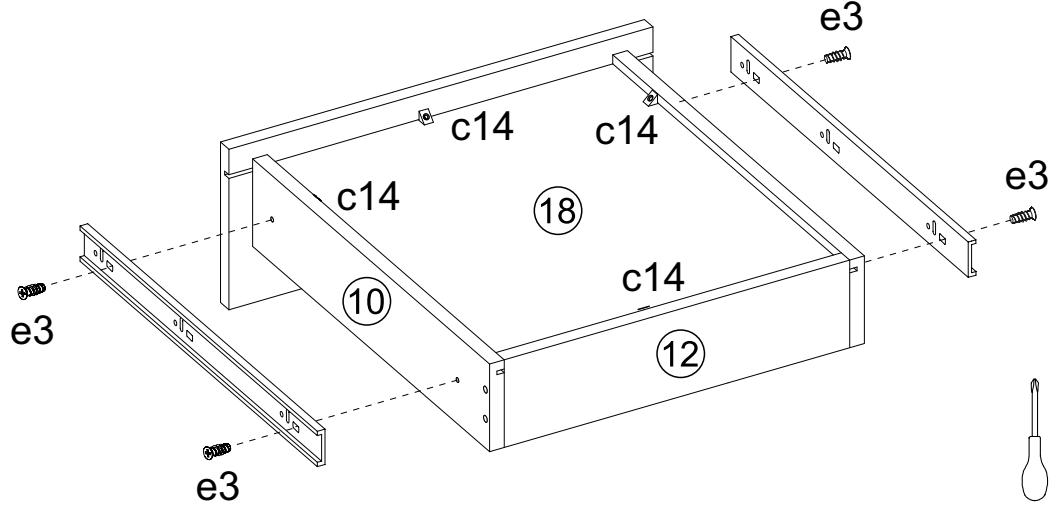
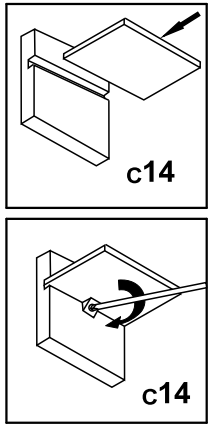

**4**  
**x2**

- 1x  w5 (L)
- 1x  w5 (R)
- 4x   $\phi 6 \times 13$  mm e3
- 4x  15x10x14mm c14



# 5

8x  φ7x50 mm e32	1x  z1
---	---

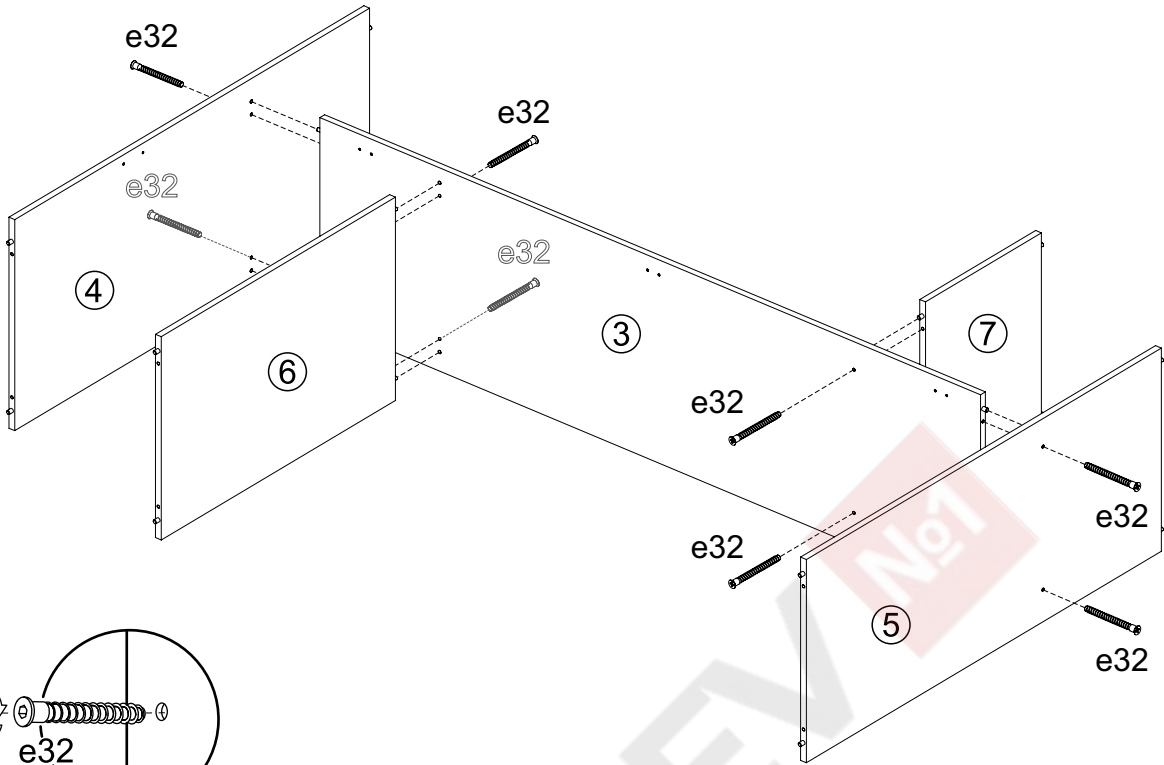

z1

# 6

12x  φ7x50 mm e32
--

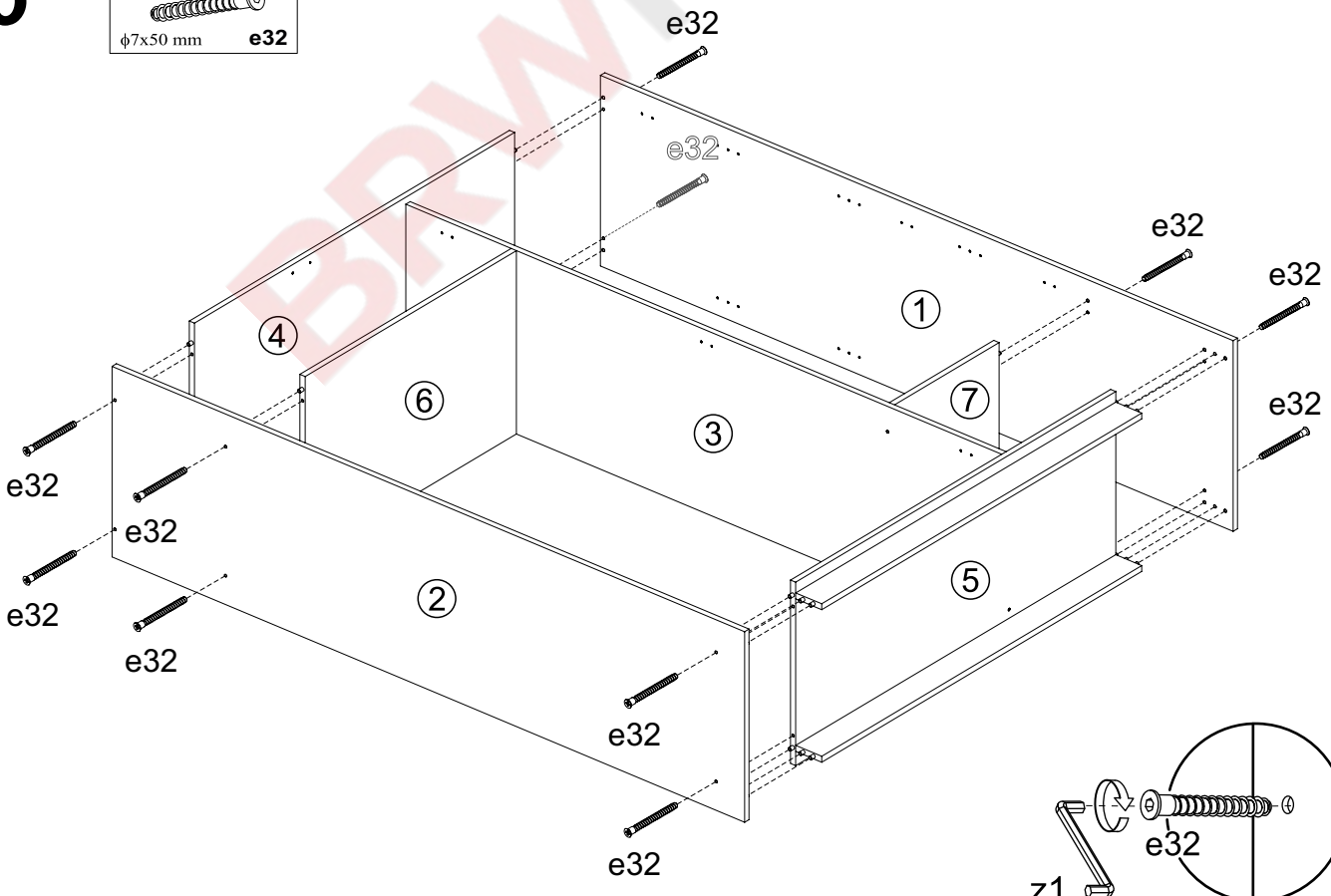

z1

# 7

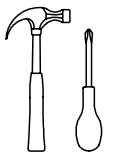
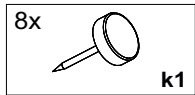
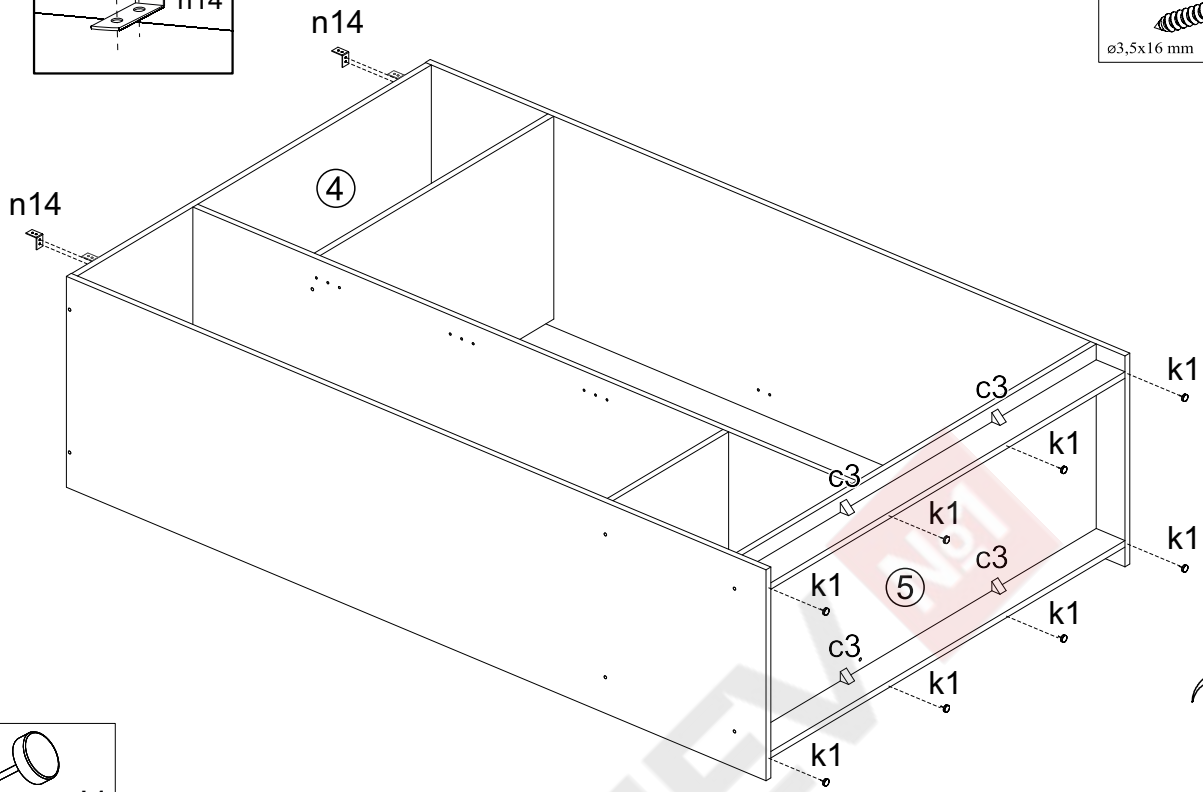
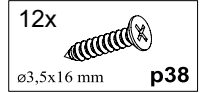
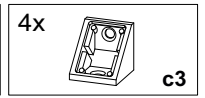
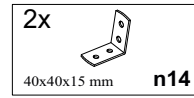
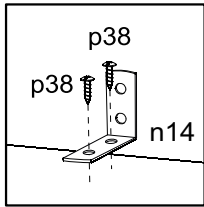

# 8

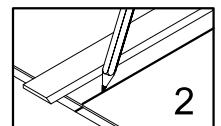
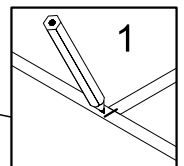
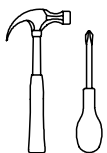
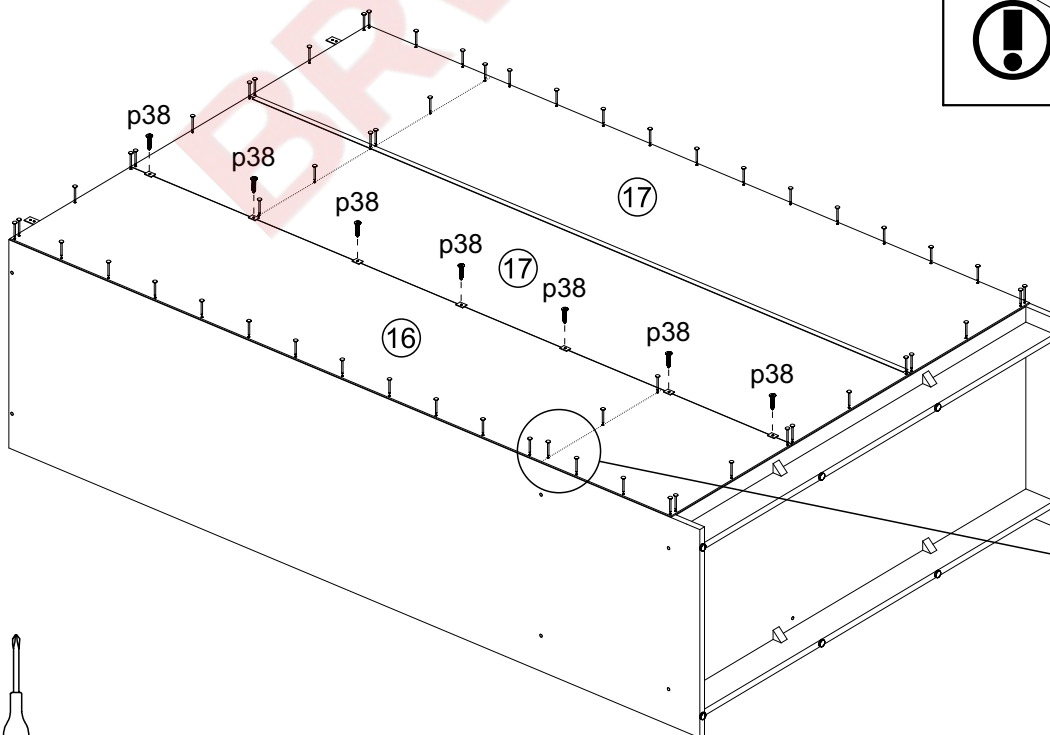
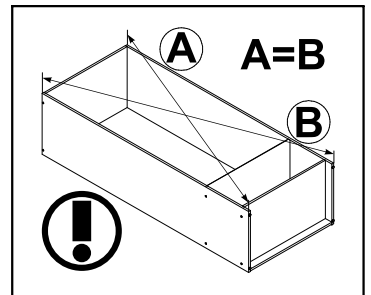
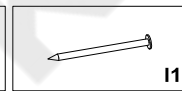
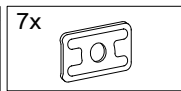
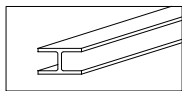

# 9

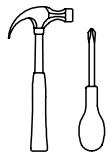
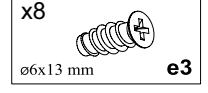
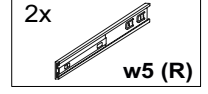
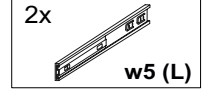
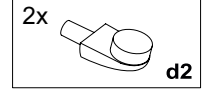
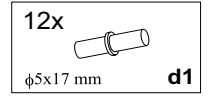
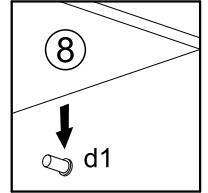
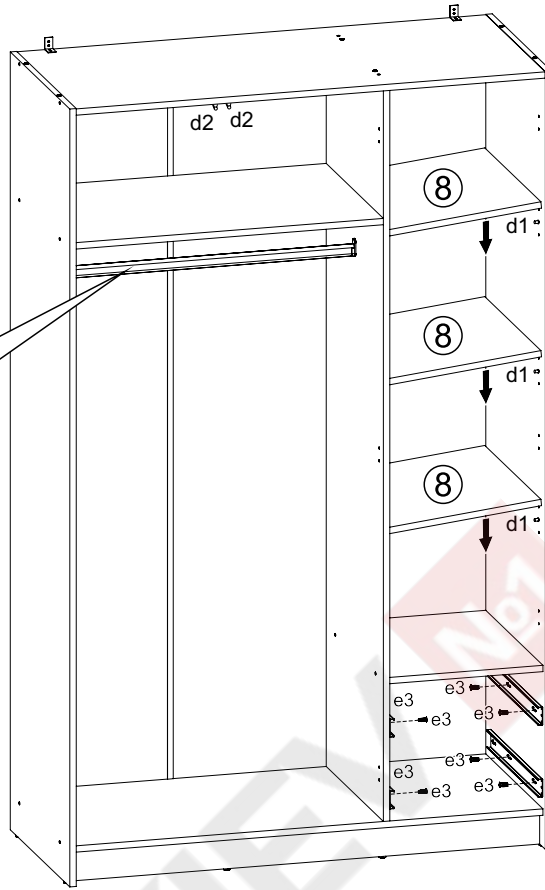
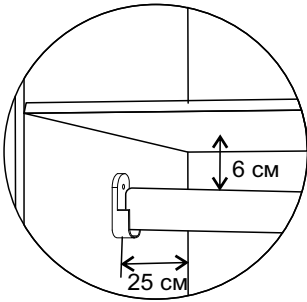
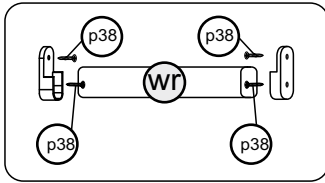
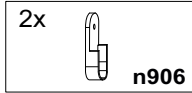
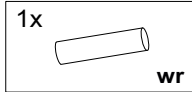

# 10

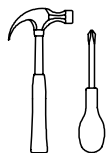
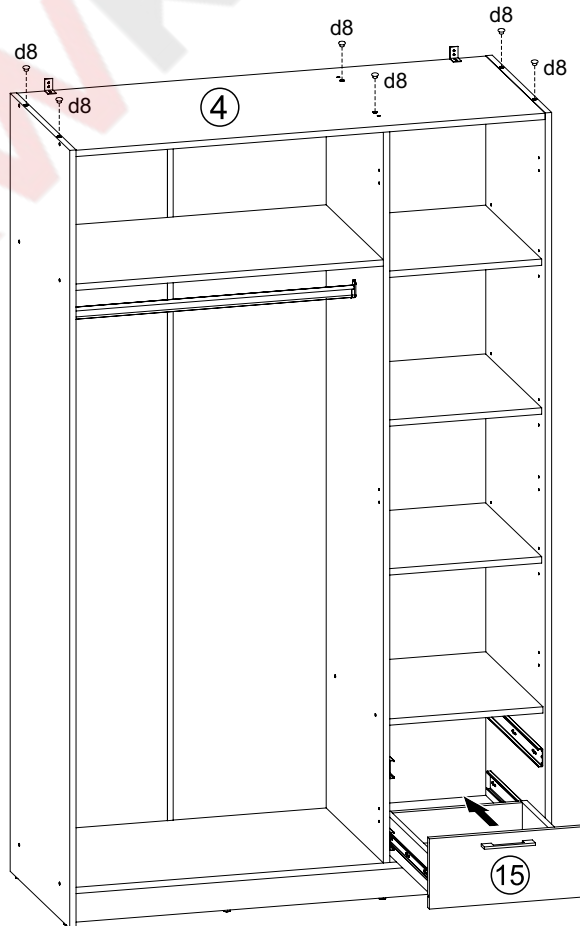
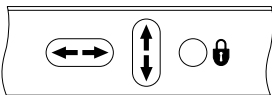
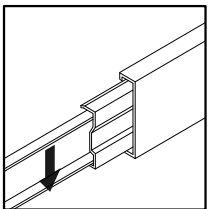
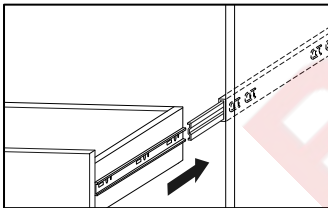
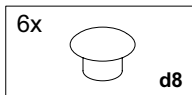

# 11

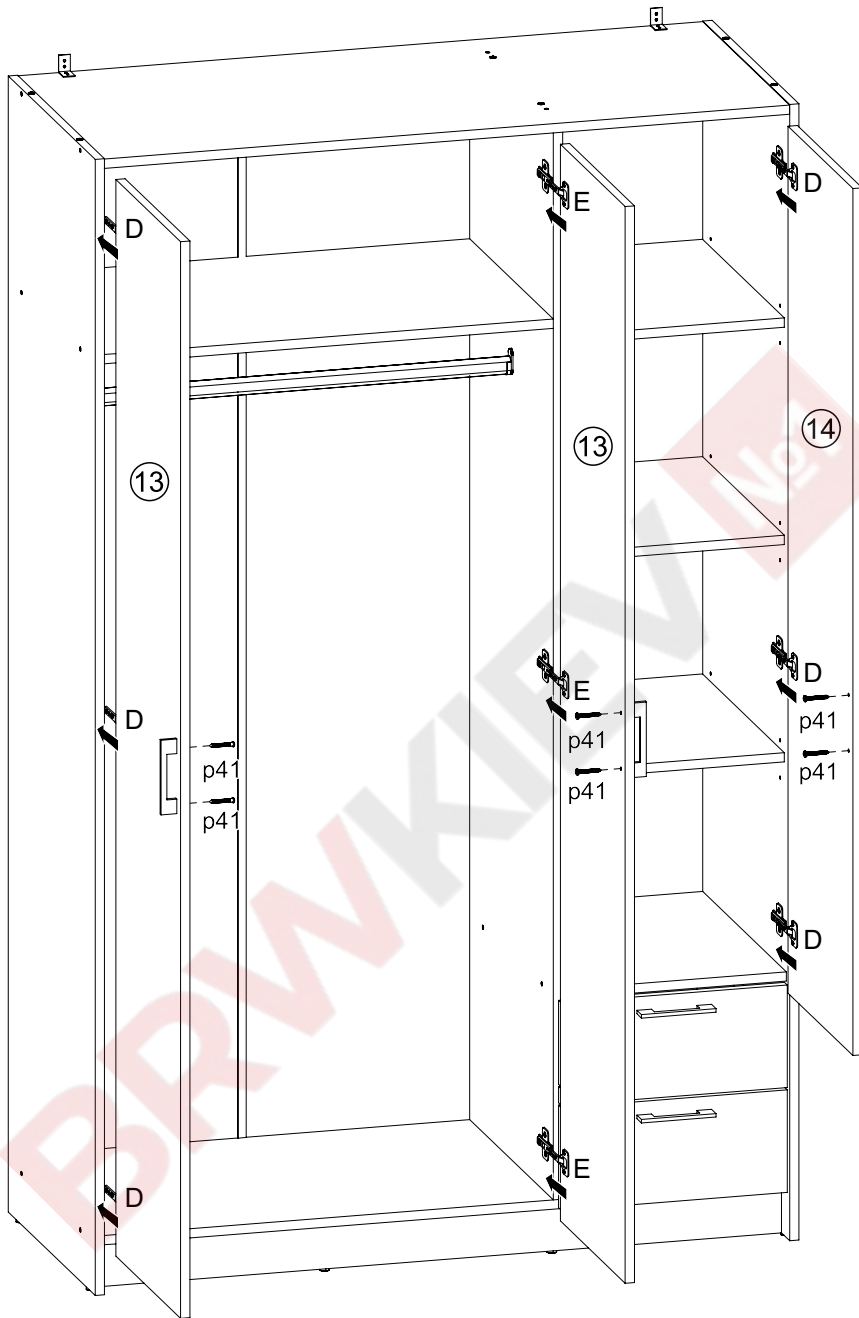
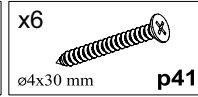
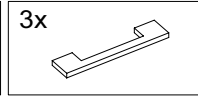
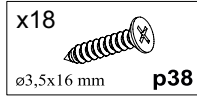
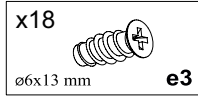
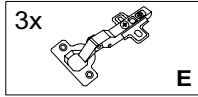
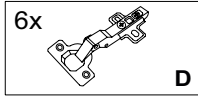

**D** - внутрішня петля

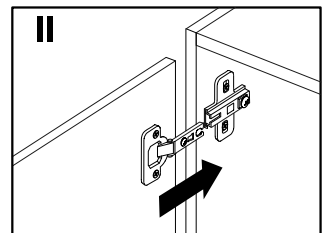
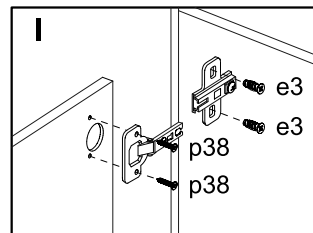
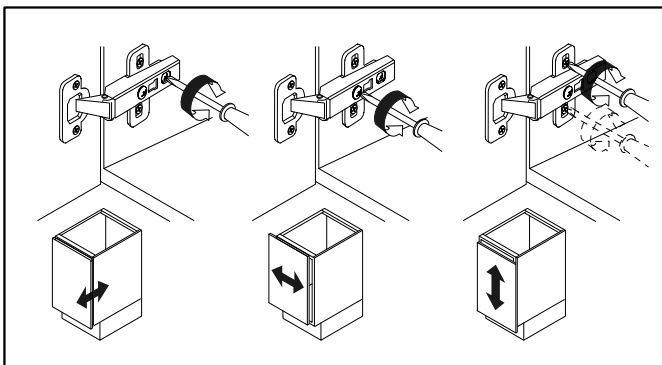

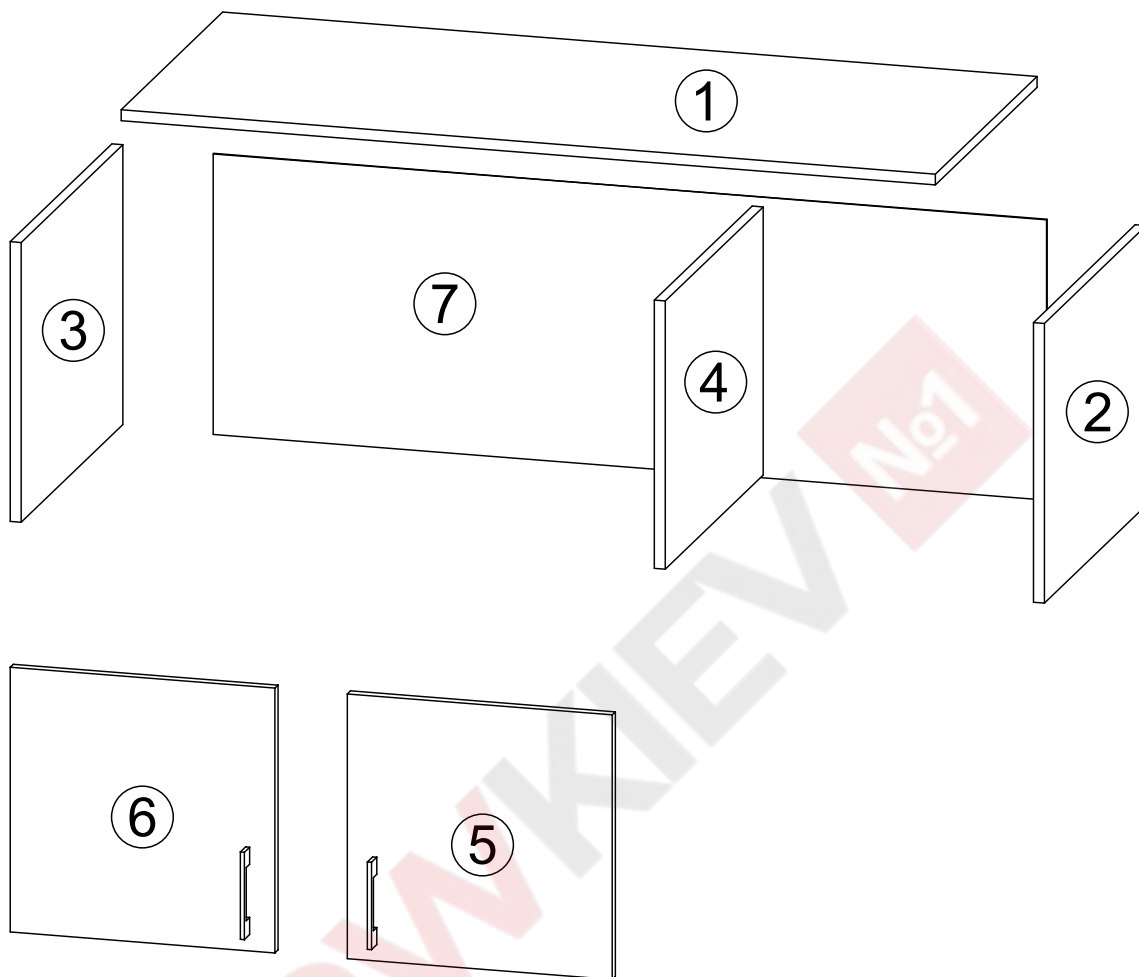

## Additional Configuration / Додаткове комплектування:



№	size / розмір		pack / уп.	qty / к-ть
1	1176	519	4/4	1
2	410	520	4/4	1
3	410	520	4/4	1
4	393	500	4/4	1
5	388	388	4/4	2
6	388	388	4/4	1
7	1204	412	4/4	1

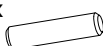

4x  D	2x  E	3x  Z1	6x  C3	6x  P38	2x  D2	12x  F1 φ8x30 mm
6x  E32 φ7x50 mm	4x  S3	1x  Z1	12x  E3 ø6x13 mm	30x  P38 ø3,5x16 mm	6x  P41 ø4x30 mm	1x  I1

# 12

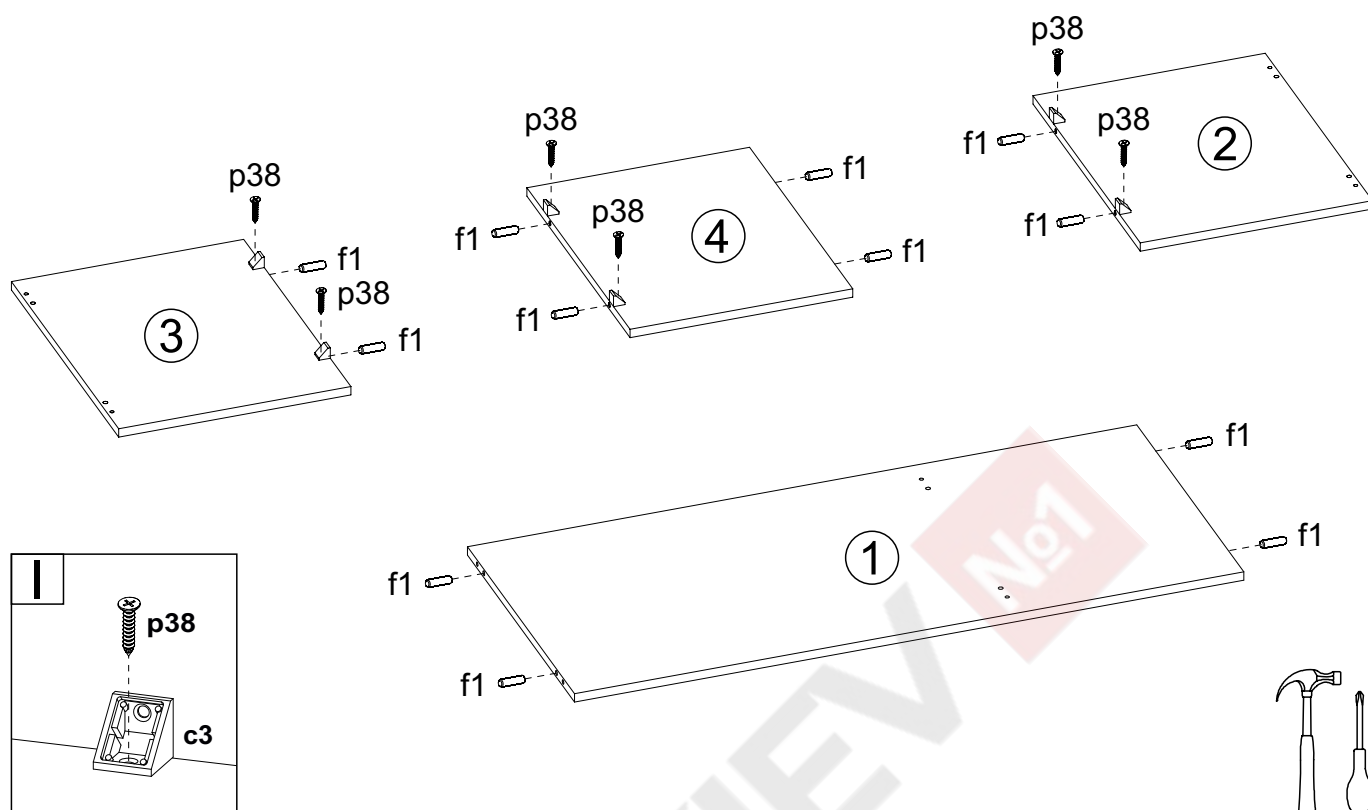
6x  c3	6x  ø3,5x16 mm p38	12x  φ8x30 mm f1
---	---	---

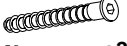

# 13

6x  φ7x50 mm e32	6x  s2	1x  z1
---	---	---

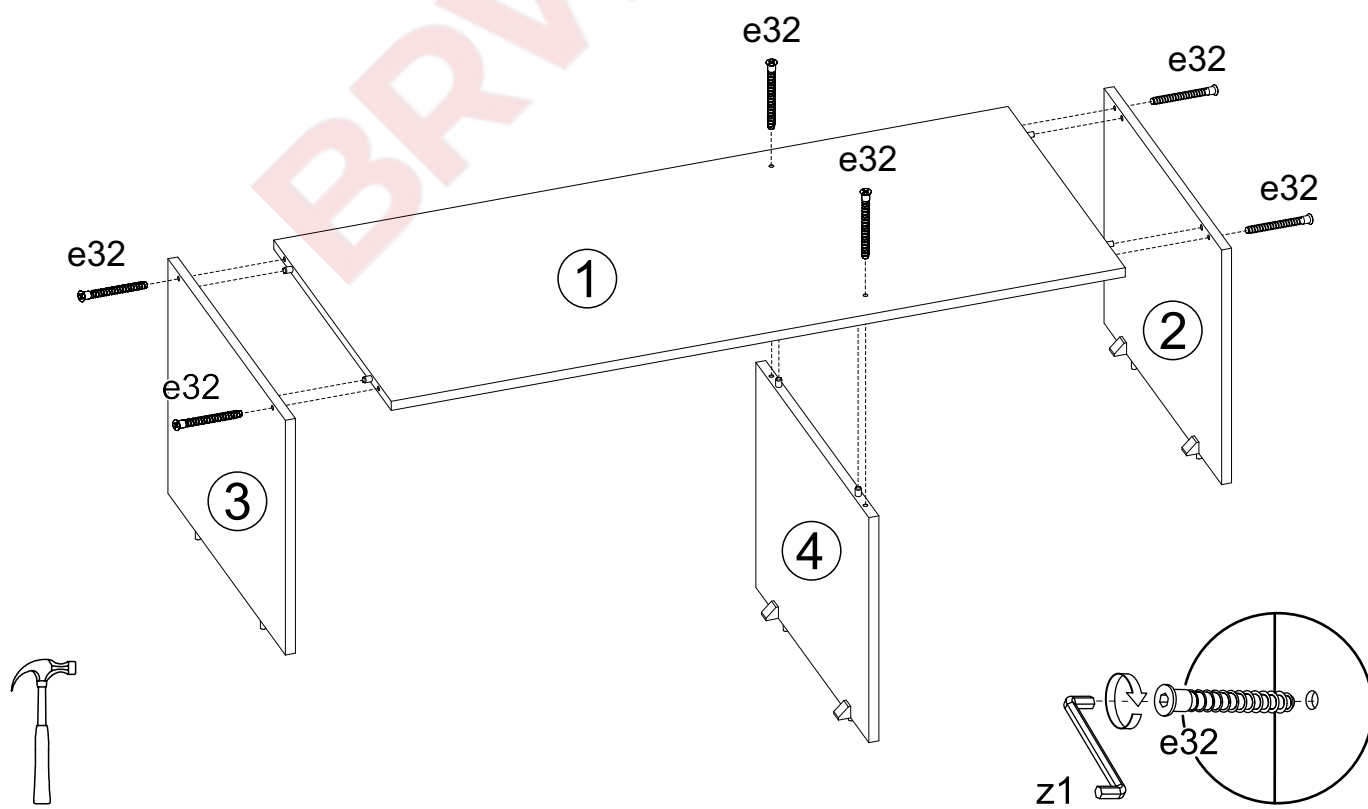

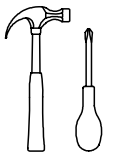
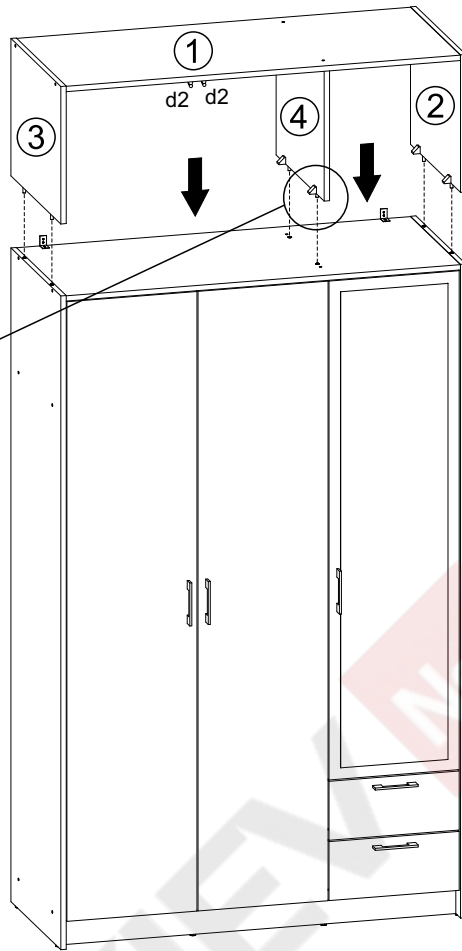
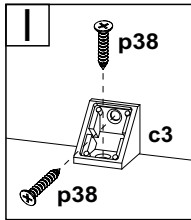
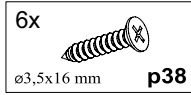
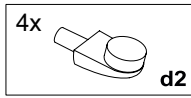

# 14

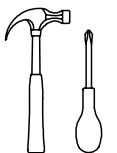
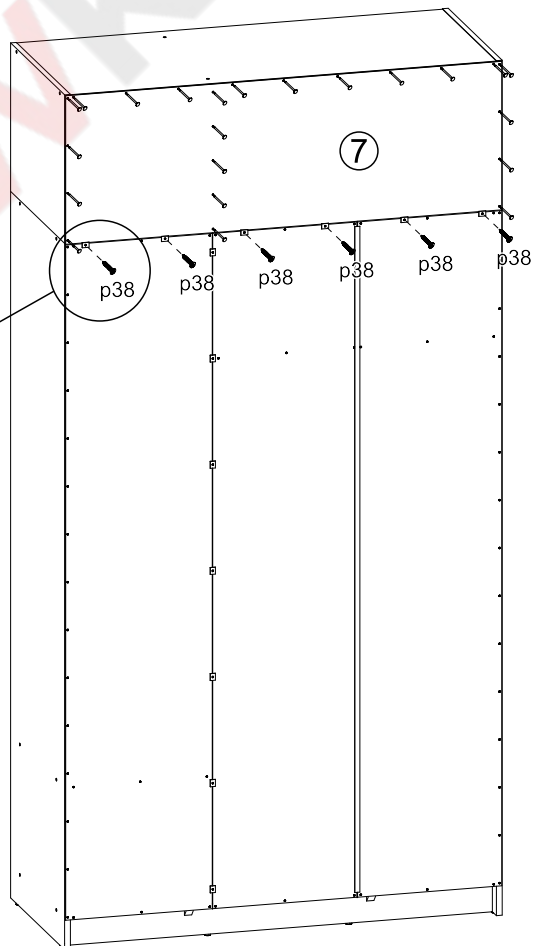
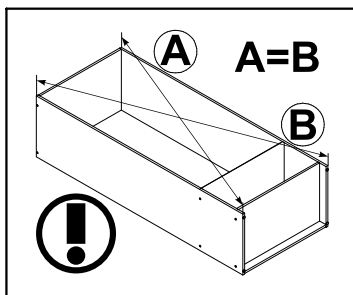
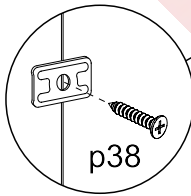
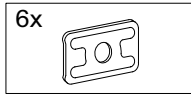
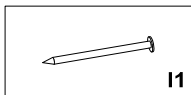

# 15



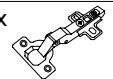
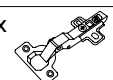

# 16

- 4x  **D**
- 2x  **E**
- 12x  **e3**  
ø6x13 mm
- 12x  **p38**  
ø3,5x16 mm

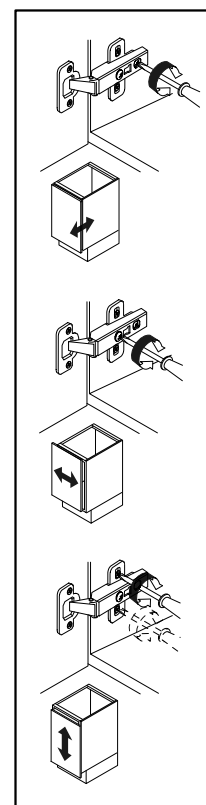
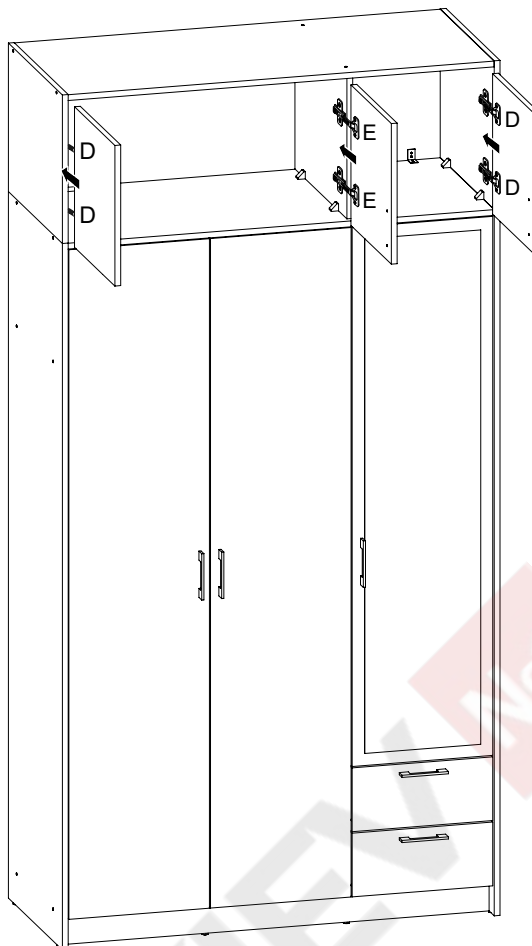
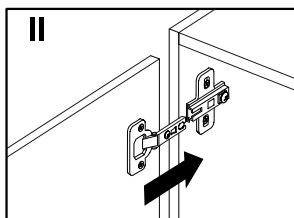
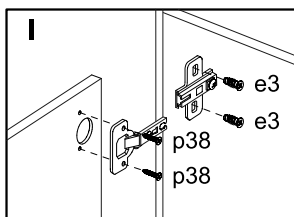
**D** - внутрішня петля

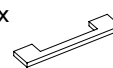

# 17

- 3x 
- 6x  **p41**  
ø4x30 mm

