

Instalation manual

NORTON: WIE_66_HW

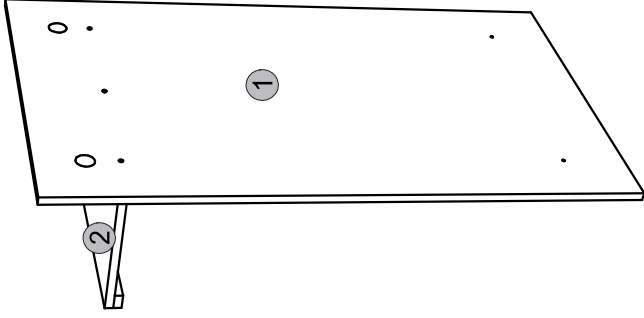
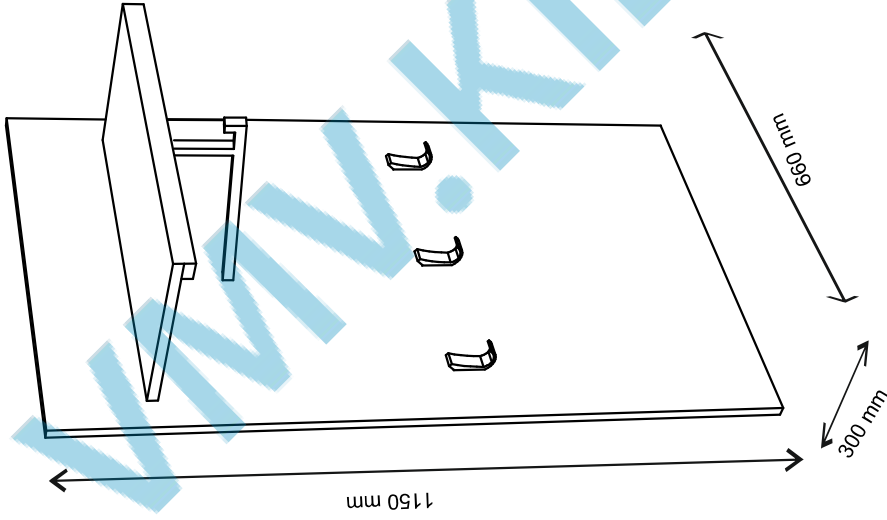
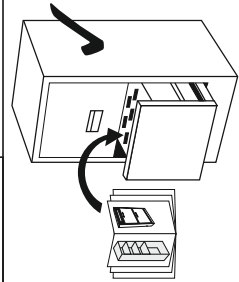
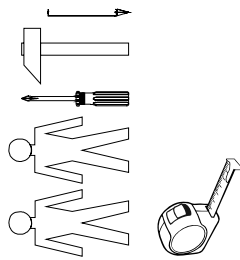
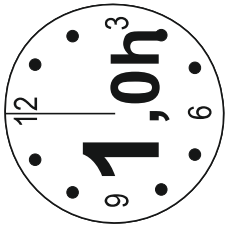
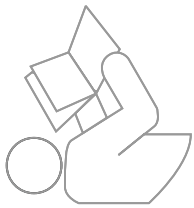

Element symbol	Dimensions	Code	Package
1	1150 660 16	1 N-048	1/1
2	560 284 16/32	1 N-047	2/2

- 1x g30
- 2x j8
- 3x g101
- 2x e3
- 2x f1
- 4x e19
- 1x z1
- 3x e1
- 6x p18
- 2x p17
- 2x g2
- 2x f3

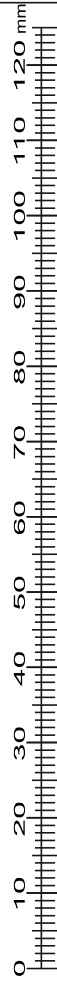

1

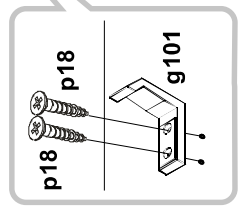
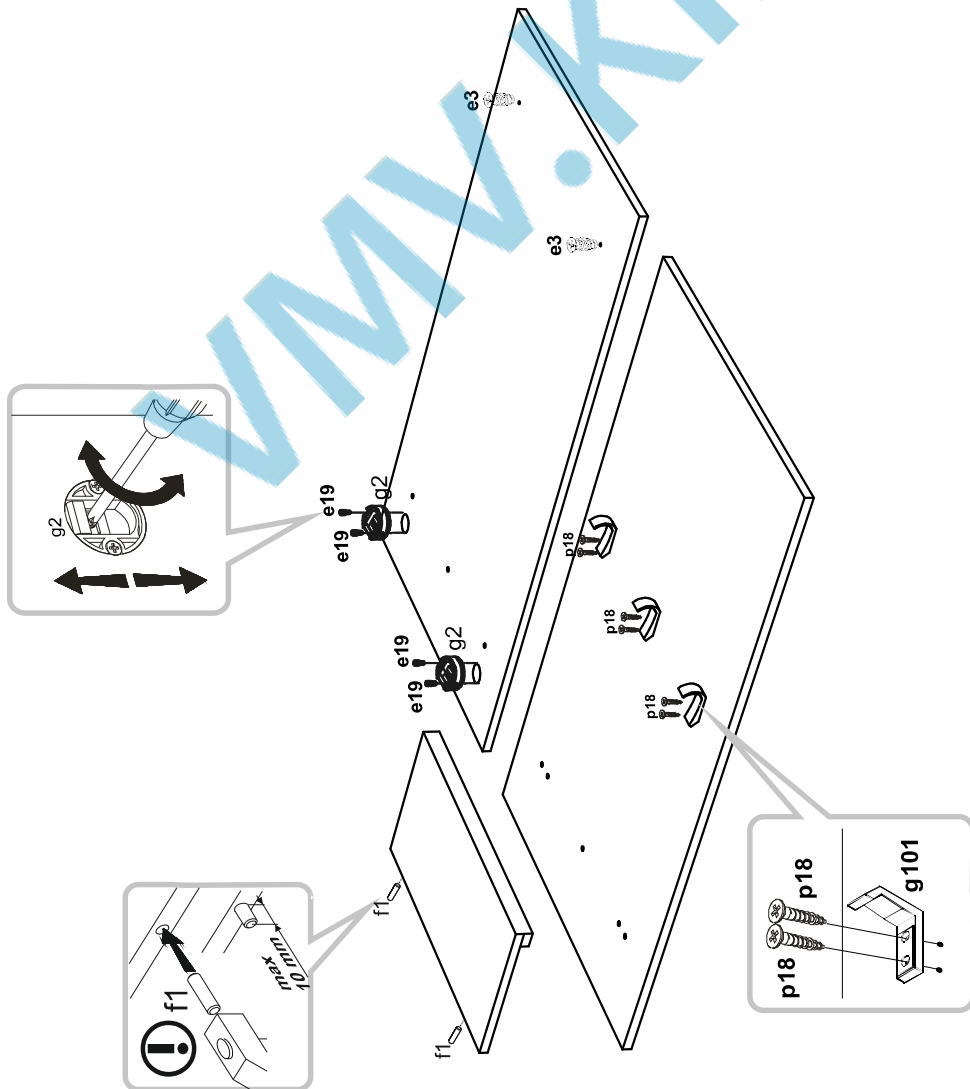

2

